



**ABUS**  
CRANE SYSTEMS

# Overhead cranes

# ABUS cranes make light work of lifting.

ABUS is one of Europe's leading crane manufacturers, offering customers tailor-made solutions for efficient material handling and individual service from design through to maintenance. ABUS has been ensuring high quality and precision right down to the smallest component for more than four decades now.

ABUS crane systems cover the entire load range up to 120 t \* and can easily be adapted to any fac-

tory shape or application conditions. The wide range of accessories available means that ABUS cranes are ideally suited for special applications. ABUS cranes are highly versatile and extremely reliable and have a number of features which by no means all manufacturers offer as standard equipment. Whether you need lifting, lowering, linear handling or area coverage, ABUS cranes help you keep everything under control.

## ABUS travelling cranes

ABUS travelling cranes, designed for handling loads up to 120 tonnes\*, are the ideal solution for heavy lifting and wide spans. The ABUS travelling crane range includes four series designed for different applications and operating conditions: single girder, double girder, under-slung and single girder wall travelling cranes.







**ABUS underslung travelling cranes** are installed on ceiling mounted tracks rather than free standing or building columns. Advantageous side approach dimensions allow the optimum use of the entire width of the production.



**ABUS single girder travelling cranes** ensure efficient material handling even where very little space is available in production halls or warehouses. ABUS single girder travelling cranes are available with rolled section or box girders. Each model is available in different girder connection versions to allow a space-saving configuration and an optimised highest hook position.



**ABUS double girder travelling cranes** achieve the maximum load capacity of up to 120 tonnes.\* They are available in various configurations and feature the versatility required for additional requirements. For example, higher crane travel speeds, maintenance walkways, trolleys with service platforms and auxiliary hoists are all features which can easily be implemented.

\*Details of higher load capacities and wider spans on application.

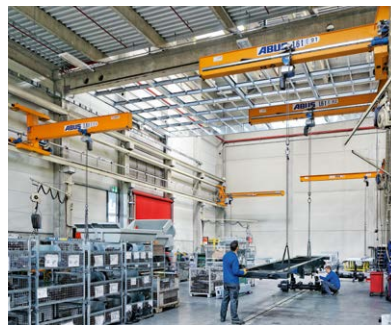

**ABUS single girder wall travelling cranes** and ABUS single girder semi-goliath cranes are installed on a separate track below other types of travelling crane. They are the ideal solution for serving several working areas at the same time. The ABUS single girder wall travelling crane is designed for spans up to 12 m and load capacities up to 5 tonnes.



The **ABUS single girder semi-goliath crane** is designed for spans up to 15 m and Safe Working Loads up to 10 tonnes.



## ABUS ELV, ELK and ELS single girder travelling cranes: a high-profile solution for low buildings



ABUS single girder travelling cranes allow efficient material handling with load capacities up to 16 t and spans up to 39 m even in halls with low ceilings. With a minimal safety clearance between top of crane and factory roof, and the compact dimensions of ABUS crane girders, it is possible to make full use of the available height and to reduce the cost of a new building.

The ABUS range of single girder travelling cranes includes a variety of girder connection versions for highly versatile adaptation to the space and dimensions available. The compact design of these units allows very high hook positions. For new buildings, version 3 is the ideal solution, offering the smallest side approach. In addition, the ABUS range includes a wide variety of accessories for many different special applications.

ABUS ELV travelling cranes are equipped with sturdy section girders while ELK and ELS cranes feature torsionally rigid welded box girders. In addition, side-mounted trolleys on ABUS ELS single girder travelling cranes allow maximum use of the available lifting height.



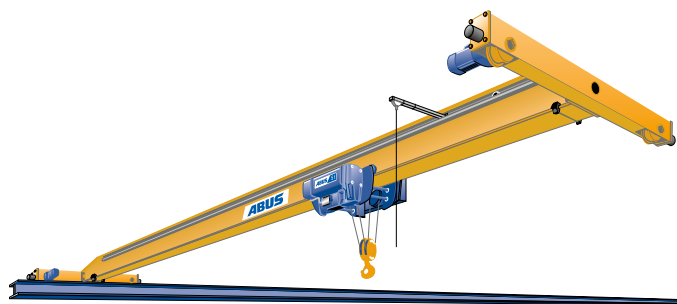

Model	Load capacity* [t]	Max. span* [m]
<b>ELV</b> single girder travelling crane with rolled section girder	up to 5	18,5
	up to 6,3	17,5
	up to 8	17
	up to 10	15
<b>ELK</b> single girder travelling crane with welded box girder	up to 5	29,5
	up to 10	27,5
	up to 16	22
<b>ELS</b> single girder torsion box crane with side-mounted trolley	up to 6,3	39
	up to 8	35
	up to 10	34

\*Details of higher load capacities and wider spans on application.

### Main girder connection versions to suit factory conditions – for ELV and ELK

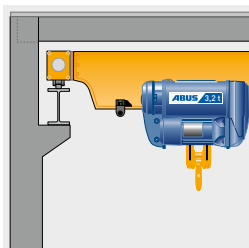

Stooped down configuration  
Version 1

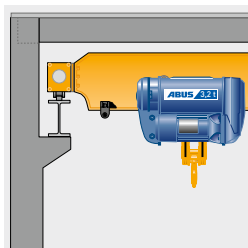

Stooped down configuration  
Version 2

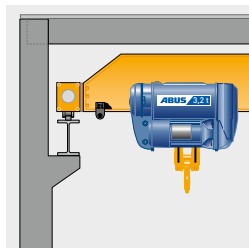

Standard main girder  
connection configuration  
Version 3

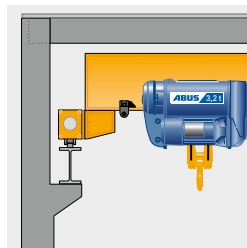

Stooped up configuration  
Version 4

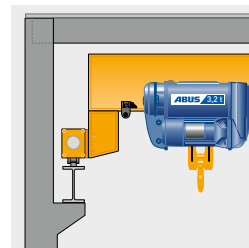

Stooped up configuration  
Version 5

### for ELS

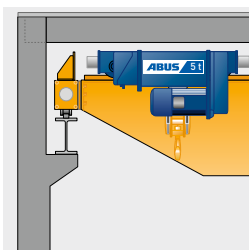

Stooped down configuration  
Version 1

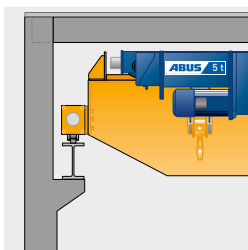

Stooped down configuration  
Version 2

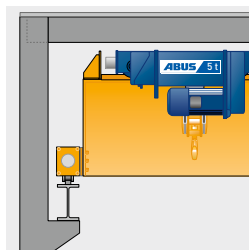

Standard main girder  
connection configuration  
Version 3

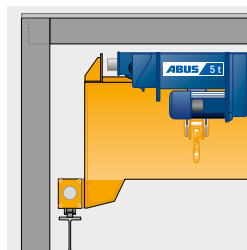

Stooped up configuration  
Version 4



The ideal solution for a new factory:  
the ABUS ELK single girder  
travelling crane with long angle  
chamfer adapted to suit the build-  
ing haunch (version 3), optimising  
available height.





ABUS single girder travelling cranes can be equipped with identical but also with differing girder connection versions for each track. In this way, you can divide a wide factory into two sections, allowing highly flexible material handling.

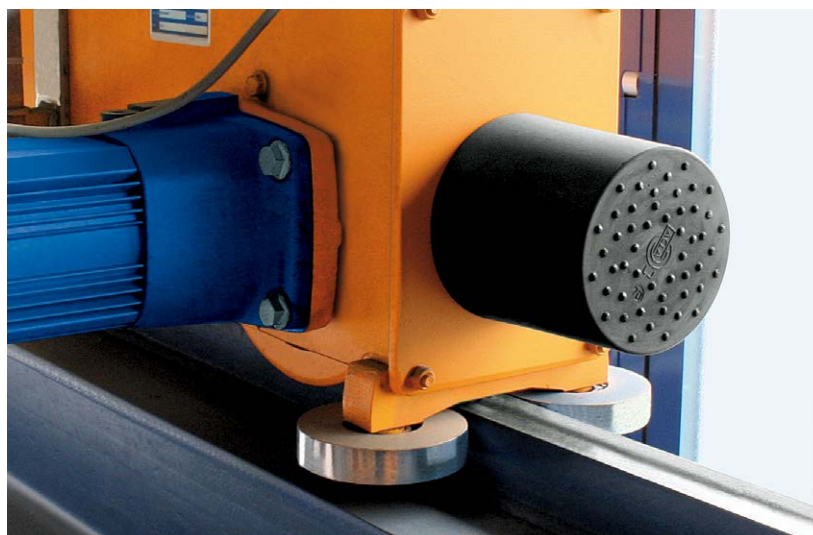

Optional: thruster rollers offer an even more exact method of crane travel guidance, reducing skewing forces.





ABUS radio remote control gives crane operators maximum freedom of movement, which is especially important where visibility is poor

and for lifting heavy loads or controlling travelling cranes on different levels.





Raised-up crane bridge configurations are the ideal solution for special situations and buildings with difficult conditions.



The LED matrix display is available as a special option and informs about the current load in the hook even from distance.



The tandem operation of travelling cranes makes it easier to handle bulky loads.



## ABUS ZLK double girder travelling cranes: the heavy brigade



\*Details of higher load capacities and wider spans on application.

Two girders are simply stronger than one, making ABUS double girder travelling cranes the ideal solution for the area coverage handling of heavy loads up to 120 t.\* Like all ABUS factory cranes, these units are available with a number of main girder connection versions to best suit new or existing buildings and the best in functionality, versatility and convenience. In addition, the

ABUS range includes a wide variety of accessories for many different special applications. ABUS ZLK double girder cranes feature welded box beams. All the sections used for main girders and end carriages are computer-optimised for high performance and low weight, benefits that pay in terms of strength and cost efficiency. ABUS double girder travelling cranes are available for

spans of up to 40 m \* and feature the versatility needed for special requirements. For example, higher crane travel speeds, service platforms, trolleys with walkways and auxiliary hoists are all features that can easily be implemented.



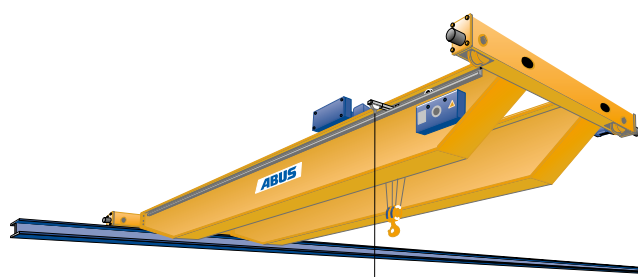

Model	Load capacity* [t]	Max. span* [m]
ZLK double girder travelling crane with welded box girder	up to 40	40
	up to 50	33
	up to 100	30

\*Details of higher load capacities and wider spans on application.

### Main girder connection versions to suit individual factory conditions

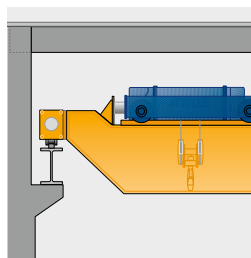

Stooled down configuration\*

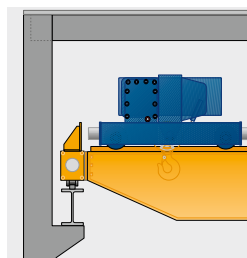

Standard main girder connection configuration – Version 1

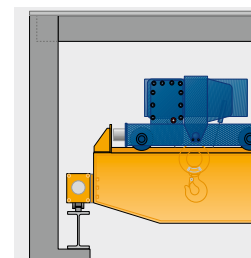

Stooled up configuration Version 2

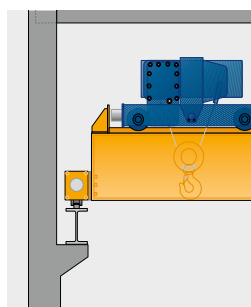

Stooled up configuration Version 3

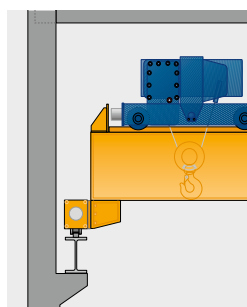

Stooled up configuration Version 4

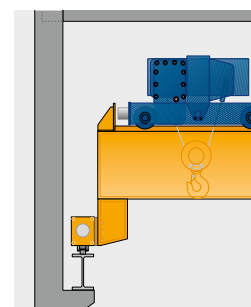

Stooled up configuration Version 5

\* Shown in combination with a stooled down low headroom hoist.



In the photographed application shown, the ABUS overhead travelling crane operates the crane flap, allowing the crane to travel back inside.

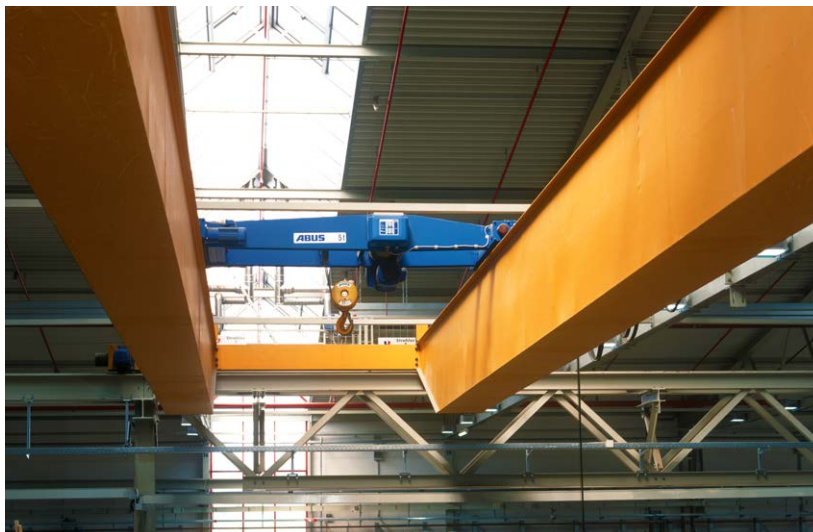

Lowered trolleys allow double-girder travelling cranes to be installed even where there is little space above the crane track. The higher position of the crane bridge with a lowered trolley may be a decisive advantage, for example when handling bulky machines or large tanks.

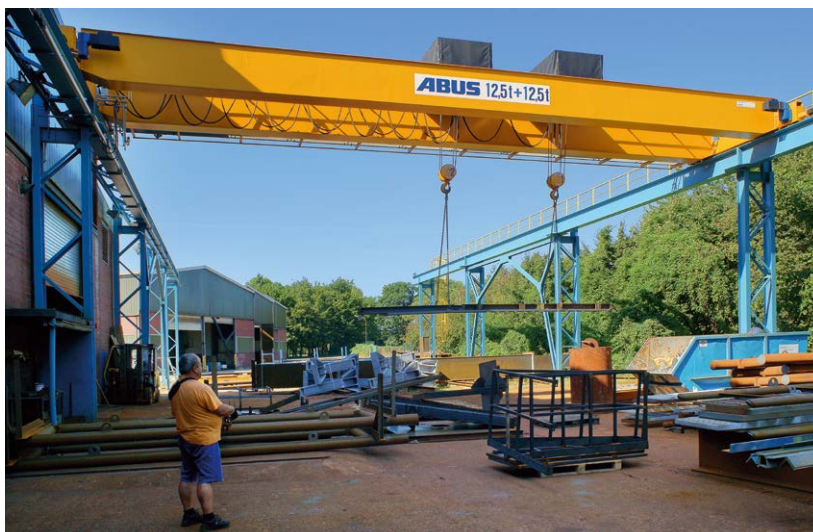

The electronic synchronisation control system allows synchronised lifting with several hoists, ensuring secure and precise load positioning at all times, even with minimal hook spacing.





The end carriage may be mounted on eight wheels for even load distribution. Heavier loads can then be carried on a smaller crane track and the reinforcement otherwise needed in existing buildings may not be required.





If a certain lifting height is only required in part of a hall, ABUS travelling cranes can be installed on different levels. In this example, an ABUS ELS single girder torsion box crane is used on the higher level, with an ABUS ZLK double

girder travelling crane with a DQA ultra low headroom hoist on the lower level. This configuration ensures the safety distance required and maximises the available lifting height.





Two synchronised trolleys using spreaders ensure the reliable positioning of long loads.



With maintenance walkways and crab unit with service platforms, all the components of the crane system are easily accessible, a crucial advantage for maintenance work.



ABUS two fall wire rope hoists are designed for high lifting speeds and load capacities up to 20 t.



## ABUS DLVM, EDL and EDK underslung travelling cranes High performance under special circumstances



Complex factory configurations pose special problems, but they are easy to solve with ABUS underslung travelling cranes. The crane track is mounted directly on the factory ceiling and not on free standing structural or building columns, allowing efficient material handling solutions even in tight spaces with difficult design conditions.

With minimum side approach dimension and cantilevers to suit individual conditions, ABUS underslung travelling cranes make full use of the space available. The highest hook position can also be raised by installing the main girder up between the end carriages. These cranes are designed for load capacities up to 8 t and spans up to 25 m.

DLVM and EDL travelling cranes are equipped with rolled section girders while EDK cranes feature torsionally rigid welded box girders. A full range of accessories is available.





Model	Load capacity* [t]	Max. span* [m]
<b>DLVM</b> underslung travelling crane with rolled section girder and welded main girder connection	up to 3,2	14
<b>EDL</b> underslung travelling crane with rolled section girder and bolted main girder connection	up to 5	17,5
	up to 6,3	17
	up to 8	9
<b>EDK</b> underslung travelling crane with box girder and bolted main girder connection	up to 6,3	25
	up to 8	13

\* Details of higher load capacities and wider spans on application.

### Main girder connection versions to suit individual factory conditions – for EDL and EDK

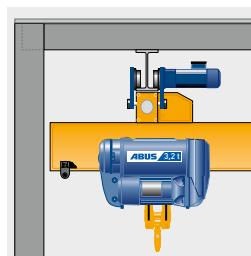

Standard main girder connection configuration – Version 1 (variable cantilever for minimum side approach dimension)

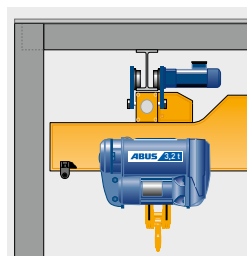

Standard main girder connection configuration Version 1, "angled" (variable overhang for minimum side approach dimension)

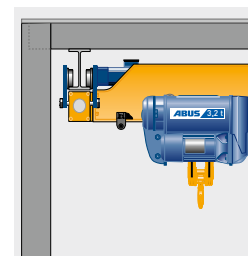

Stooped up configuration Version 2 (optimised hook height without crane girder cantilevers)

## The ABUS EWL single girder wall travelling crane: a high-profile solution for the lower working level.



The ABUS single girder wall travelling crane is designed for operation on a lower level beneath a large travelling crane system. These cranes provide additional handling possibilities and ensure smooth and troublefree material handling between different working areas.

A wall travelling crane installed at right angles across the hall can serve several working stations. ABUS single girder wall travelling cranes are available for load capacities up to 5 t with jib lengths up to 12 m.



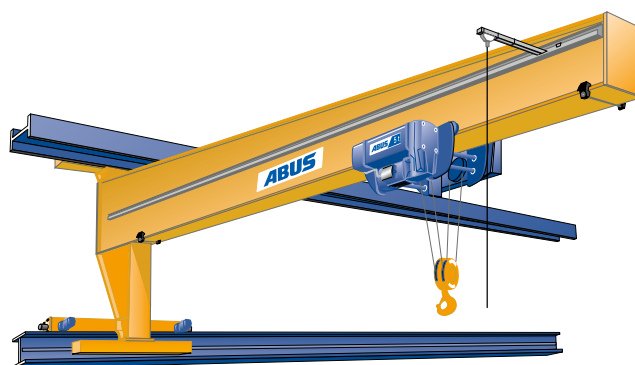

Model	Load capacity* [t]	Max. jib length* [m]
EWL single girder wall travelling crane with welded box girder	up to 5	12

\* Details of higher load capacities and wider spans on application.



With two hoists in tandem operation, ABUS single girder wall travelling cranes can also be used for the precise positioning of long loads.



## ABUS EHPK single girder semi-goliath crane: a powerful partner on more than one level.



The ABUS single girder semi-goliath crane is the ideal solution for operation in the areas beneath a large travelling crane system. Similar to the ABUS single girder wall travelling crane, due to its configuration at right angles to the downshop tracks, this crane can serve several adjacent work stations. The ABUS single girder semi-

goliath crane is available with Safe Working Loads of up to 10 t and spans up to 15 m.

The torsion resistant and sturdy box girder construction allows crane travel without any lateral guidance of the portal leg at floor level. The lower end carriage travels either directly on the even and load bearing shopfloor, or in the case of

higher wheel loads, on a suitable steel plate mounted flush to the plant floor. A raised or countersunk guide rail with the consequent trip hazards are avoided. The EHPK is fitted with lift-off prevention devices on the high level end carriage as well as obstacle detection and clearly visible rotating lights at floor level.





Model	Safe Working Loads* [t]	Max. spans* [m]
EHPK single girder semi-goliath crane with welded box beam	up to 5	15
	up to 10	10

\*Details of higher load capacities and wider spans on application.



Guide rollers on the high level end carriage as standard.



Obstacle detection on the floor level end carriage as standard and no guide rail on the floor required.

# Standard equipment on ABUS travelling cranes – setting an example

## ABUS quality – right down to the last detail

ABUS travelling cranes are supplied with comprehensive high performance standard equipment including many features often only offered as accessories. These features make ABUS cranes especially safe and reliable and allow precise adaptation to the customer's individual needs. Like the cranes themselves, each of these components items meets stringent quality requirements and has been thoroughly tested.



## Motor circuit breakers

offer additional safety for cranes with ABUS wire rope hoists by limiting the thermal load on crane and hoist trolley travel motors in two-phase and severe inching operation and when the drive system is blocked. After the circuit breaker has been tripped, there is no need to replace a fuse before restarting the hoist or crane.



**ABUS plug-in connectors** make contact easily and reliably. They are already preassembled and reduce repair and maintenance times to a minimum. Using these connectors, hoists, geared motors and control units can be connected up quickly and easily without the assistance of an electrician.

## ABUS contactor-type control systems

bring together all the control signals from the crane system. These systems feature modular design for maximum versatility and easy adaptation to customers' requirements. Interfaces to the main items of optional equipment (radio remote control, signal horn, limit switches, anti-collision devices, etc.) are pre-installed ready for connection. The clear configuration with ducted wiring makes maintenance work easier. Timers prevent excessive inching and power contactors are generously sized for long service lives.

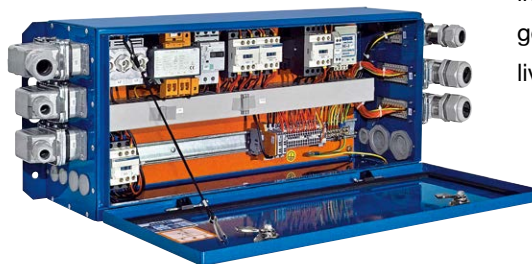





**ABUCommander** push button pendants feature state-of-the-art ergonomic design and can be used with all ABUS travelling cranes with contactor-type control systems. They ensure safe activation of all crane functions and have a slightly angled configuration for holding in a natural, low-fatigue position. ABUCommanders feature non-ageing rugged plastic housings that are corrosion and weather proof. The connection between handset and control cable is designed with bayonet connections, making it possible for the handset to be released and removed, if required.

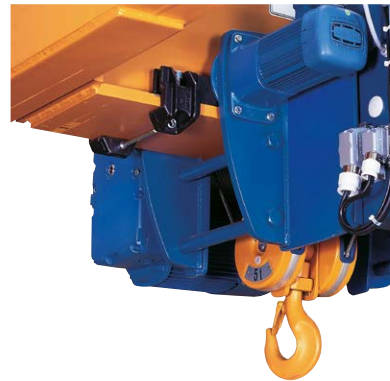

**ABUS clamping buffers** can be used for a variety of functions: for limiting crane travel, fixing hoists at specific positions, absorbing impact energy or securing trolleys against rolling away. They are adjustable and can be installed as required. In particular, they can be used temporarily, offering considerable versatility. Especially for monorail hoist trolleys, ABUS offers clamping buffers designed for adaptation to current conditions.



The **ABUS LIS-SE load indicator system** features a comprehensive range of switching and monitoring functions. The system offers an extremely short load detection time of only a few hundredths of a second, effectively protecting ABUS wire rope hoists against overloading. The measurement principle allows the load on the hoist to be limited without reducing the lifting height available.

The main functions include:

- overload protection
- part-load switches
- operating hours meter
- current monitoring for motor protection
- redundant circuitry for additional safety
- mains power and fault diagnostic
- braking with use of motor as a generator to reduce wear on brakes
- load population recorder (optional)
- load display (optional)

## ABUS accessories: Just what you need for individual solutions

With the comprehensive range of accessories offered by ABUS, every ABUS travelling crane can be precisely adapted to the customer's requirements, ensuring optimum performance. The range includes additional safety devices and equipment for additional functions such as electric limit switches, integrated load analysis systems, crane lighting and maintenance walkways.



### Radio remote control

Radio remote controls give crane operators greater freedom of movement, allowing them to choose the position which gives the best view of their working area and effectively saving time. ABUS offers radio remote controls with joystick or compact push-button hand held transmitter. ABUS radio remote controls are also suitable for multi-user operation, with parallel access to several cranes.



### The ABUS tandem control system

allows the crane operator to control two electrically coupled travelling cranes at the same time. Ideally, the ABUS radio remote control system should be used in combination with the tandem control system. With this control configuration, two crane operators can control the two cranes separately, or one operator can control both cranes, either separately or together.



The **ABULiner** is an effective solution when precise positioning is required with variable speed hoists. This frequency converter also allows the maximum speed to be increased above the rated speed when lifting part/reduced loads. ABULiners are also available for crane and trolley travel.



The **ABUS synchronization control system** ensures that even minor differences in lifting speed caused for example by different loads on the hooks are evened out when several hoists with the same rated lifting speed are operated in parallel. In this way, differences in the levels of hooks with the same or different loads can be kept within defined limits. The ABUS synchronization control system is an electronic system which can be retrofitted cost-effectively to pole-changing standard hoist motors without mechanical modifications or electronic switches.



**ABUS cross-type limit switches** limit long travel and cross travel, automatically slowing or stopping the crane or the hoist at the end of the track. These limit switches may also be applied for crane zoning if it is necessary to divert a hoist on a crane around a prohibited area. The switch is operated by a switching lug installed on the crane track or on the crane bridge.



#### Load measurement systems

**LIS-SE:** Load measurement and evaluation system that measures the voltage and current on all three phases of the hoist motor. Optional functions: load display in the push button pendant and load population recorder.

**LIS-SV:** this load indicator system offers all the functions of the LIS-SE system, but uses load measurement sensors in addition to motor current measurements. This system is an attractive proposition for systems with several hoists where the overall total load of all hoists needs to be limited. Measurement accuracy increases systemically, with the resultant load able to be shown on the pendant handset display or LED matrix display.



LED matrix display



## ABUS accessories: Just what you need for individual solutions



**ABUS crane lighting systems** effectively illuminate the working space under a crane, avoiding the shadows normally cast by crane girders working beneath normal factory lighting. Application-specific requirements include the following: Floodlight with impact-resistant halogen flashlight, crane lights with metal halide high-pressure lamp and LED lamps.



**Load suspension devices** can be used with ABUS cranes for special material handling tasks. For example, ABUS cranes can be equipped with vacuum lifting units for lifting plates or with C-hooks for handling coils.

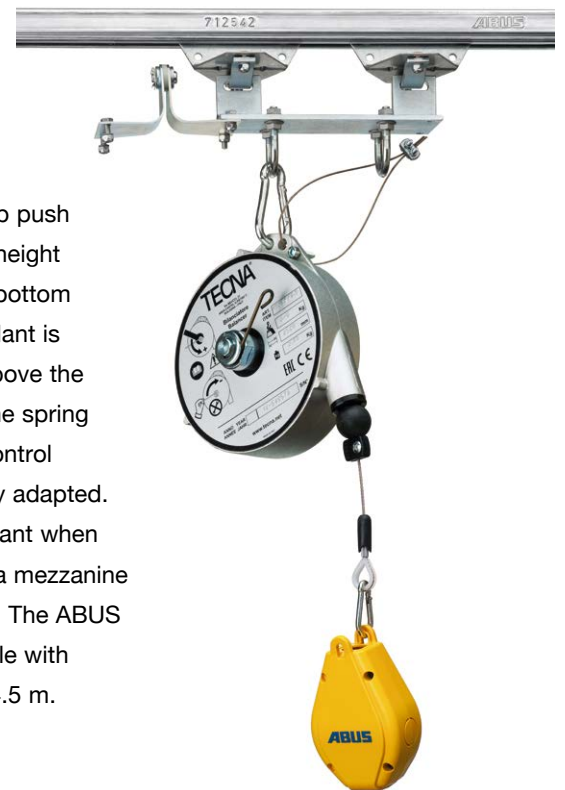

**ABUS spring reels** keep push button pendants at the height required. Normally, the bottom of the push button pendant is positioned one metre above the operating level. Using the spring reel, the length of the control cable can be individually adapted. This is especially important when operating a crane from a mezzanine floor or an assembly pit. The ABUS spring- reels are available with cable lengths of 3 and 4.5 m.





**AZS smooth starting units** and **SU-2 smooth switching relays** are the ideal accessories for the smooth handling of sensitive loads and goods using pole-changing drive systems. These electronic systems allow the crane operator to control crane and trolley travel sensitively, with adjustable acceleration and improved deceleration behaviour. Depending on individual requirements, the system can also be used separately for crane or trolley travel.



**Anti-collision device**

The ABUS anti-collision device protects cranes, preventing accidental collision via photoelectric distance measurement. Automatic switch-over to a lower speed as the two hoists approach each other is a standard feature. A shut-down function can be incorporated. ABUS can also supply collision prevention devices

designed to maintain a specified minimum spacing and other special designs. **Important:** Not suitable to be used for distancing required because of structural reasons. In such cases the light barrier system may be composed of fail-safe components and check and malfunction indicators.



**ABUS maintenance walkways**

allow access to the entire length of the crane girder, bringing all the main components of the crane system within easy reach, a major prerequisite for safe and efficient maintenance work.

## ABUS through and through: advanced production, typical precision

The high quality standards achieved by ABUS crane systems are only possible because of the extreme care taken in production at the ABUS Lantenbach plant. Our production facilities represent the state of the art, from the preparation of steel plate using high-performance blast cleaning systems and welding using machinery with automated weld sequences through to the application of the high-quality paint

system. Highly automated, highly versatile production facilities ensure an ideal combination of precision, cost-effectiveness and constant high quality levels. Highly specialised machines developed in-house, such as the mobile portal welding unit, ensure smooth and troublefree production at all times; customers can rely on rapid completion to schedule and just in time delivery. They can also be sure that all the

mechanical, electrical and electronic components of an ABUS crane have been thoroughly tested prior to shipment and that any item of equipment bearing the ABUS name represents ABUS quality through and through.

## A picture of quality: ABUS welded box girders

\*Details of higher load capacities and wider spans on application.

Depending on the individual model, ABUS travelling cranes are either fitted with rolled section girders or welded box girders. While rolled section girders are mainly used for low to medium load capacities and narrow spans, welded box girders are designed for the highest load

capacities (up to 120 t \*) and the widest spans (up to 40 m \*). Every ABUS box girder is tailored from high-grade steel plate to ensure that these units are a unique combination of strength, size, quality, reliability and precision. In this brochure, we can only give you a

first impression of the production process. If you would like more evidence of the efficiency of material flow and the performance of our production facilities, the best way is to see for yourself during a visit to our Lantenbach plant. We look forward to seeing you.



Following thorough inspection, the steel plates are derusted and descaled to ensure excellent weld quality. The shotblasting unit is equipped with four high-performance turbines and can produce surfaces to DIN 55928, Grade SA 2 1/2. It can be adjusted to any steel grade and plate thickness.





Plates of the lengths required for box girders are welded together on a PLC-controlled welding machine. The butt welding machine can process plates of different thicknesses and the automatic weld sequence control system ensures the highest welding quality possible.



Before the next processing stage, web plates are welded into place to protect the girder against twisting; stiffeners are inserted to improve the overall stability of the structure. Following assembly on the box girder line, the box girder is ready for processing by the portal welding unit.



The moving portal welding unit designed in-house by ABUS personnel welds the web plates to the upper and bottom flanges and the rails on the top of the girder. The welding unit can complete up to six welds at the same time. The high-performance burners are automatically controlled by a PLC. Following the welding of the closure plates and the installation of the end carriages, the paintwork required for the specific application is applied.

## ABUS for quality that stands out – the ABUS service

The ABUS service begins with comprehensive advice for customers. If you wish, we will be only too pleased to assist you in the planning process before you take a decision on the system you intend to purchase. ABUS prepares quotation precisely in accordance with your requirements using computer-aided systems and you can be sure of ABUS competence and commitment right through to the commissioning of your crane system. After commissioning, our world-wide service network ensures optimum availability.

**ABUS for service without frontiers.** ABUS experts offer comprehensive service not only in Europe but throughout the world. ABUS subsidiaries and international partners ensure that your crane system is ideally adapted to your technical requirements and complies with all the applicable national legislation and regulations. ABUS and its partners operate spare parts stock holding in a number of countries. You can also rely on the support of our central spare parts depot and our unique service at ABUS headquarters.

**ABUS training – designed for good service**  
ABUS sales and estimating engineers and service operatives receive thorough training at the ABUS training centre in Gummersbach and their theoretical and practical training is continually updated to maintain the high standards of our global service. Our product range, our development activities, our computer programs and our production facilities are also adapted continuously to meet the requirements of our international customers.





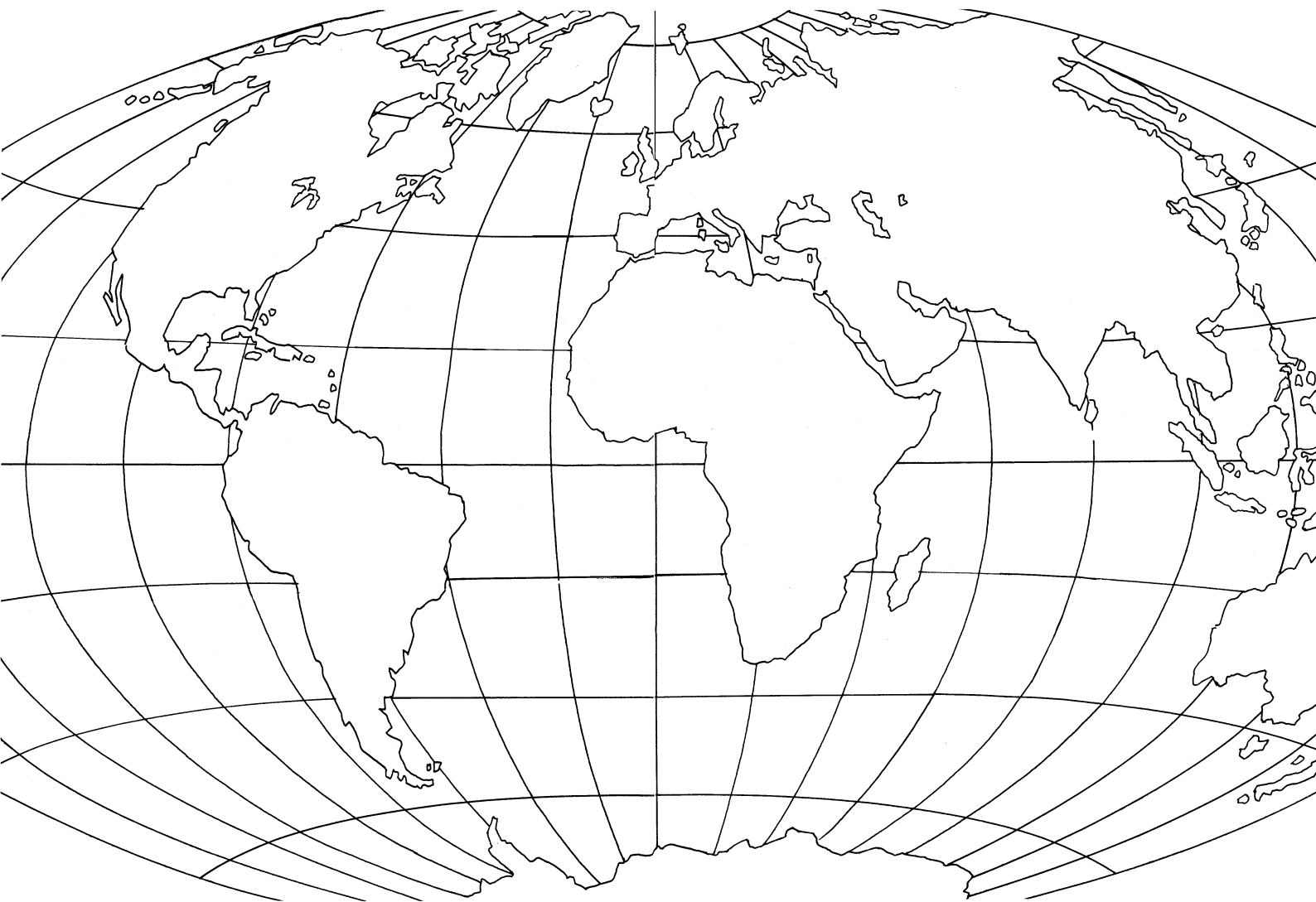

ABUS is represented in more than 50 countries throughout the world.

**A convincing service in all respects.**

- advice in the planning phase
- installation, dismantling and modification of crane systems
- inspection and overhaul of crane systems by local partners
- repair and maintenance
- upgrading and modernisation
- personnel training

# The ABUS range at a glance

\* Details of higher load capacities and wider spans on application.

## Overhead travelling cranes:

- Load capacity: up to 120 t \*
- Span: up to 40 m \* (depending on load capacity)
- Applications: area coverage
- Features: comprehensive standard equipment and wide range of accessories to suit individual requirements



## HB systems:

- Load capacity: up to 2 t
- Crane girder length: up to 22 m (depending on load capacity)
- Applications: area coverage and linear handling
- Features: highly versatile for adaptation to individual requirements, designed for modular extension, wide range of suspension hangers, low headroom options, comprehensive standard equipment and wide range of accessories



## Jib cranes:

- Load capacity: up to 6.3 t
- Jib length: up to 10 m (depending on load capacity)
- Applications: swept area coverage, mainly for use in loading or workbench applications
- Features: slewing range up to 360° depending on model

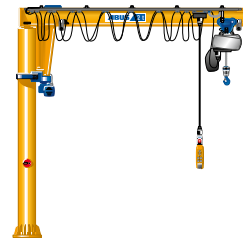

## Electric wire rope hoists:

- Load capacity: up to 120 t
- Features: compact dimensions, two lifting and travel speeds as standard feature, comprehensive standard equipment and wide range of accessories



## Electric chain hoists:

- Load capacity: up to 4 t
- Features: low headroom configuration, two lifting speeds as standard feature, comprehensive standard equipment, ready for installation, wide range of accessories



## Lightweight portal cranes:

- Load capacity: up to 2 t
- Features: with four stop rollers, easy to move, height and width individually adaptable





## The first step to your Overhead Travelling Crane

Just copy this form, complete it and fax it to us for an initial quotation without obligation.

Company: _____	Postcode/place: _____
Name: _____	Phone/extension: _____
PO Box/address _____	e-mail: _____

### Details of Overhead Travelling Crane required

#### Type/load capacity

Single girder overhead travelling crane	Double girder overhead travelling crane	Underslung overhead travelling crane	Single girder wall travelling crane	Single girder semi-goliath crane
_____ kg	_____ kg	_____ kg	_____ kg	_____ kg

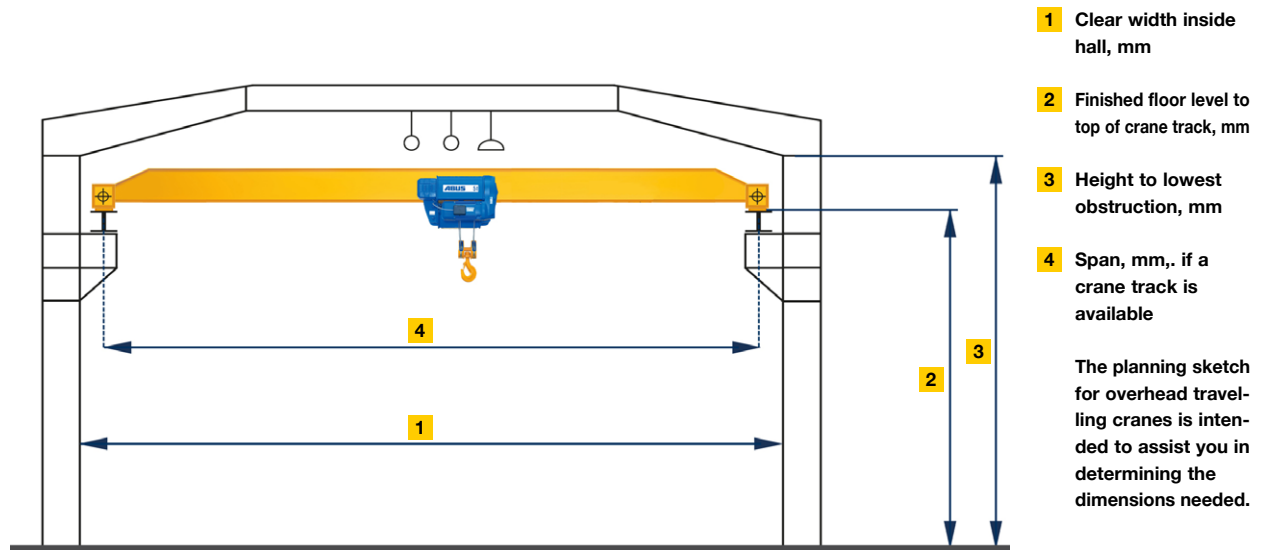

#### Building data:

<b>1</b> Clear width inside hall	_____	mm
<b>2</b> Finished floor level to top of crane track	_____	mm
<b>3</b> Height to lowest obstruction	_____	mm
<b>4</b> Span	_____	mm
Crane track length	_____	m

#### Crane track required (to be installed on existing supports):

Crane track length	_____	m
Support spacing	_____	m

## Notes

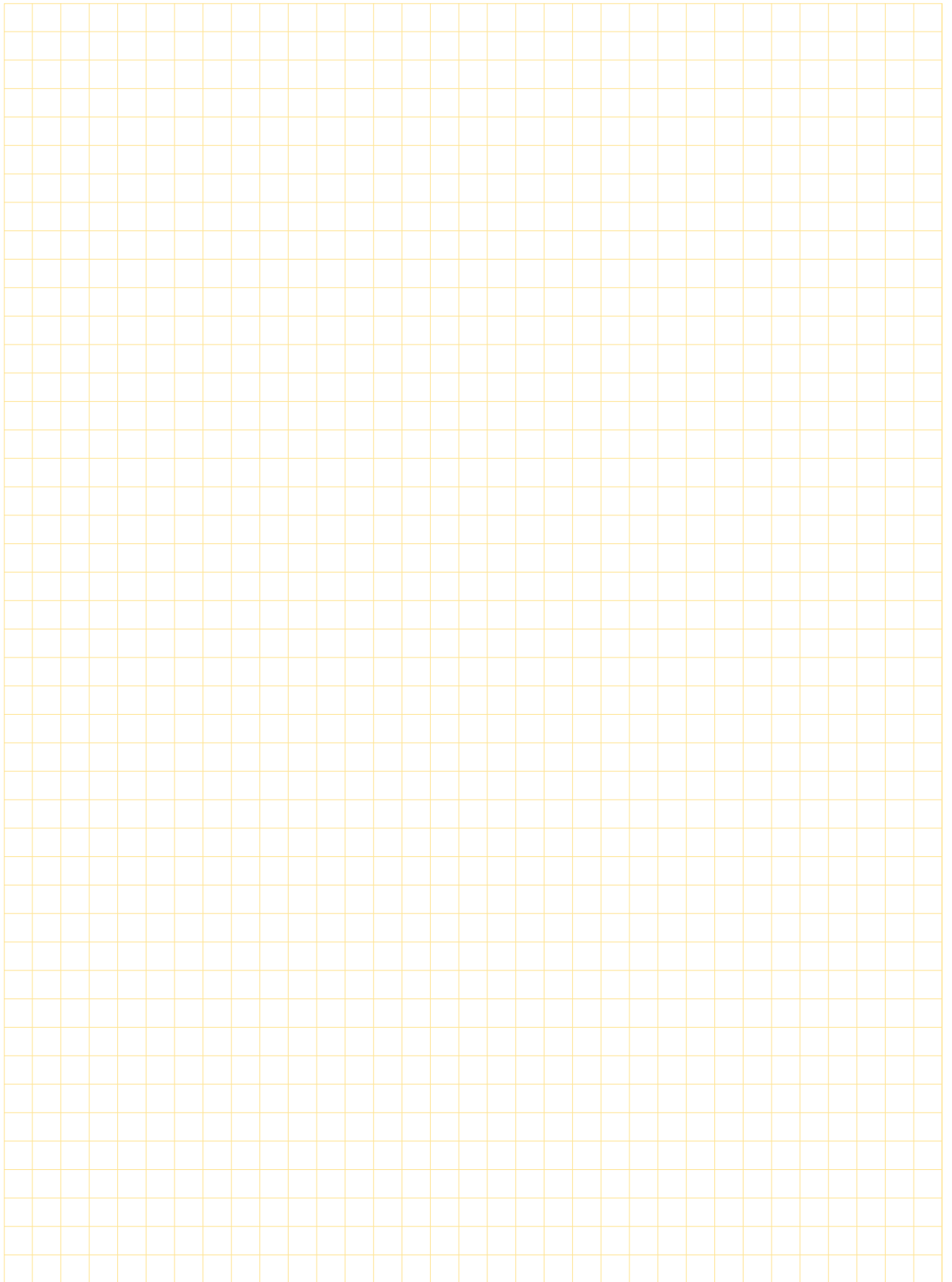



# Notes

A large grid of graph paper for taking notes, consisting of 20 columns and 30 rows of small squares.

# Further product information...

...on our entire product range will be gladly forwarded to you.

You can also view these directly and download them from our homepage.



ABUS Image brochure



The Product Overview

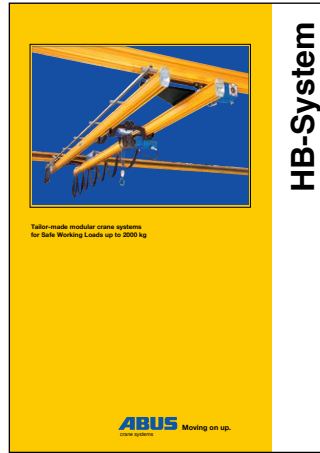

HB-System

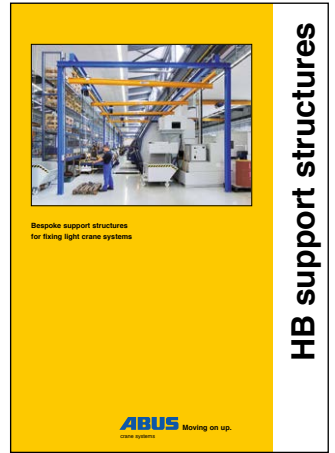

HB support structures



Jib cranes

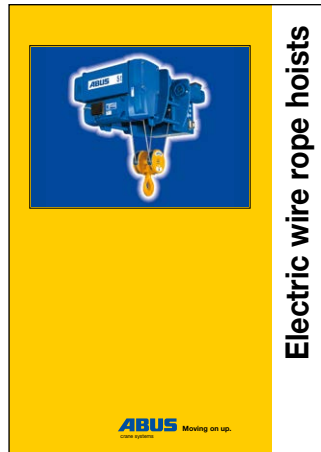

Electric wire rope hoists

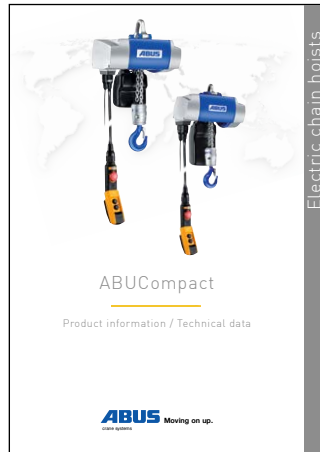

Electric chain hoists



Mobile gantries

## Please send your request

by fax to: +49 2261 37-90165

by email to: [info@abuscranes.com](mailto:info@abuscranes.com)

Name: \_\_\_\_\_

Company: \_\_\_\_\_

Street: \_\_\_\_\_

Postal code/City/Country: \_\_\_\_\_

Telephone: \_\_\_\_\_

E-mail: \_\_\_\_\_

Date \_\_\_\_\_ Signature \_\_\_\_\_

AN 12282 04.17